

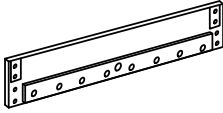

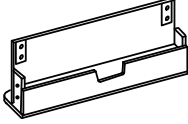

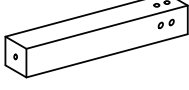





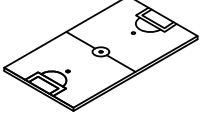







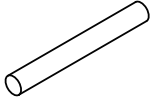
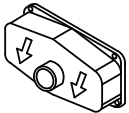





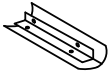
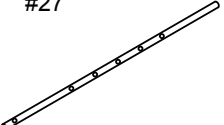
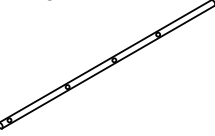
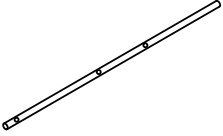
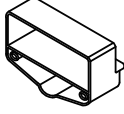

KNIGHT TABLE SPORT

R10 Academy

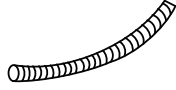
PARTS LIST & ASSEMBLY INSTRUCTIONS

| | | | | |
|--|--|---|---|--|
| #1  Long-side Boards 2PCS | #2  Short-side Boards 2PCS | #3  Legs 4PCS | #4  Support sticks 2PCS | #5  Playfield 1PC |
| #6  5/16"*2-1/2"Bolts 8PCS | #7  5/16"*3/4" Washers 24PCS | #8  5/16"*1-1/4"Bolts 16PCS | #9  F3.5*1"Screws 20PCS | #10  Counters 2PCS |
| #11  Bushings 4PCS | #12  F4*1-3/4" Screws 4PCS | #13  T4*1/2" Screws 36PCS | #14  Chrome Steel Bars 2PCS | #15  Ball Collectors 2PCS |
| #16  Leg Levelers 4PCS | #17  Rod Handles 8PCS | #18  Rod End Caps 8PCS | #19  Bumpers 16PCS | #20  Nuts 26PCS |
| #21  Ball cups 2PCS | #22  Plastic Washers 16PCS | #23  Players 22PCS | #24  8#*1"Bolts 26PCS | #25  8#*5/8"Screws 2PCS |
| #26  Silver Strips 4PCS | #27  5-Man Rods 2PCS | #28  1&3-Man Rods 4PCS | #29  2-Man Rods 2PCS | #30  Ball Receivers 2PCS |
| #31  Soccer Balls 4PCS | #32  Wrench 1PC | #33  Ball Return Tubes 2PCS | #34  Abnormity steel 4PCS | |

STEP 1

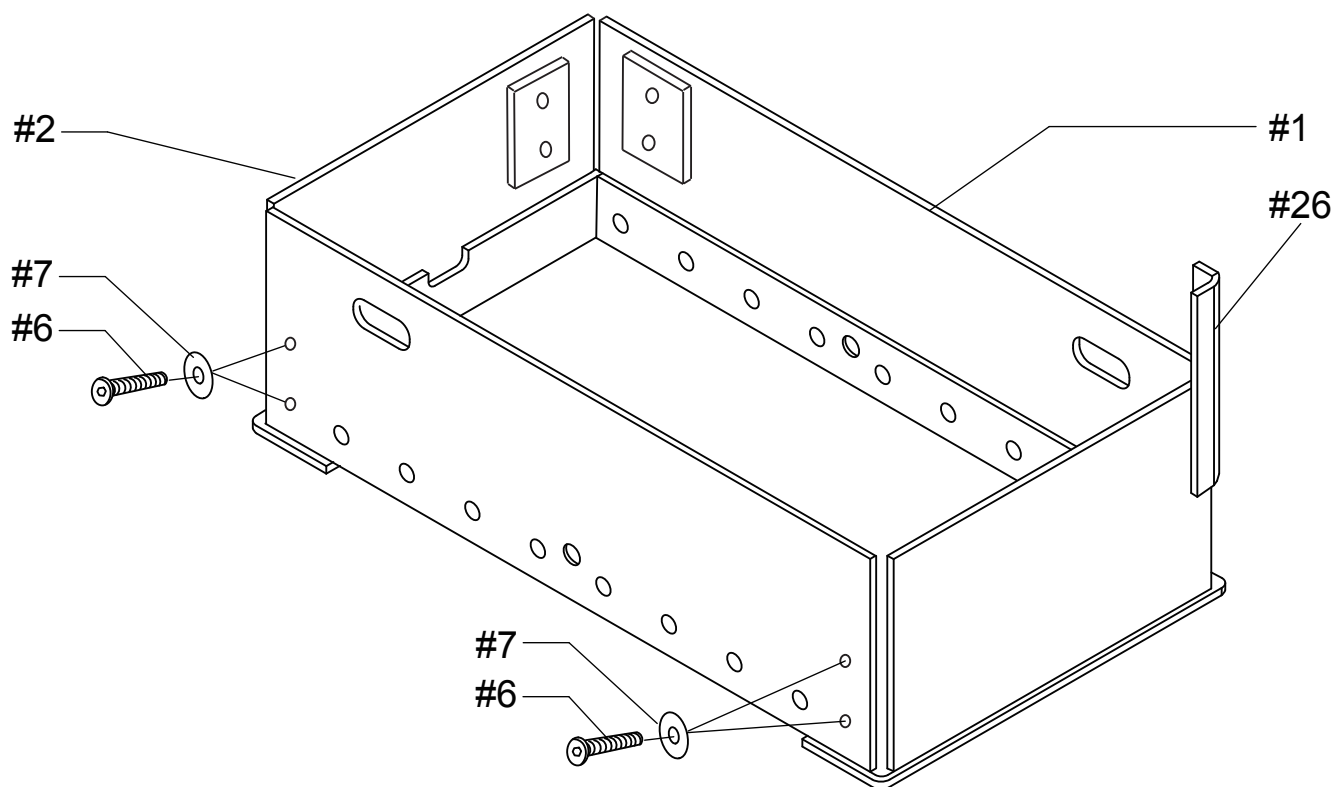

STEP 2

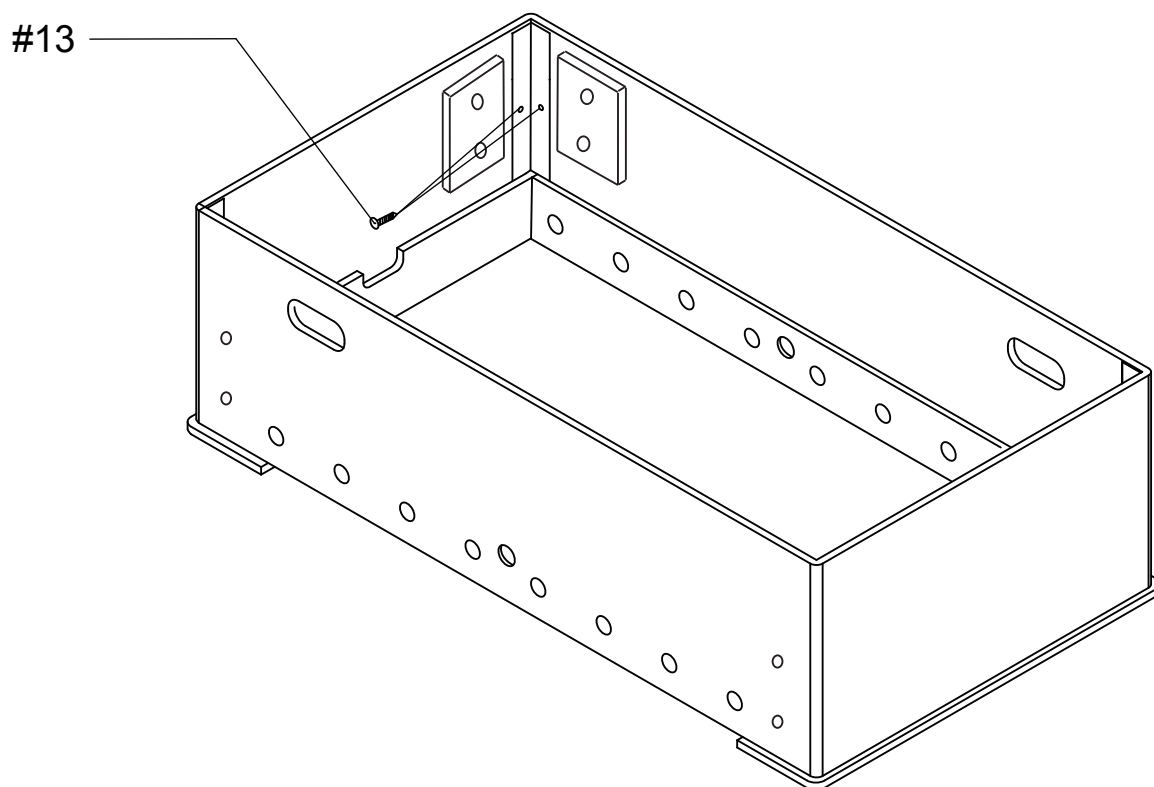

STEP 3

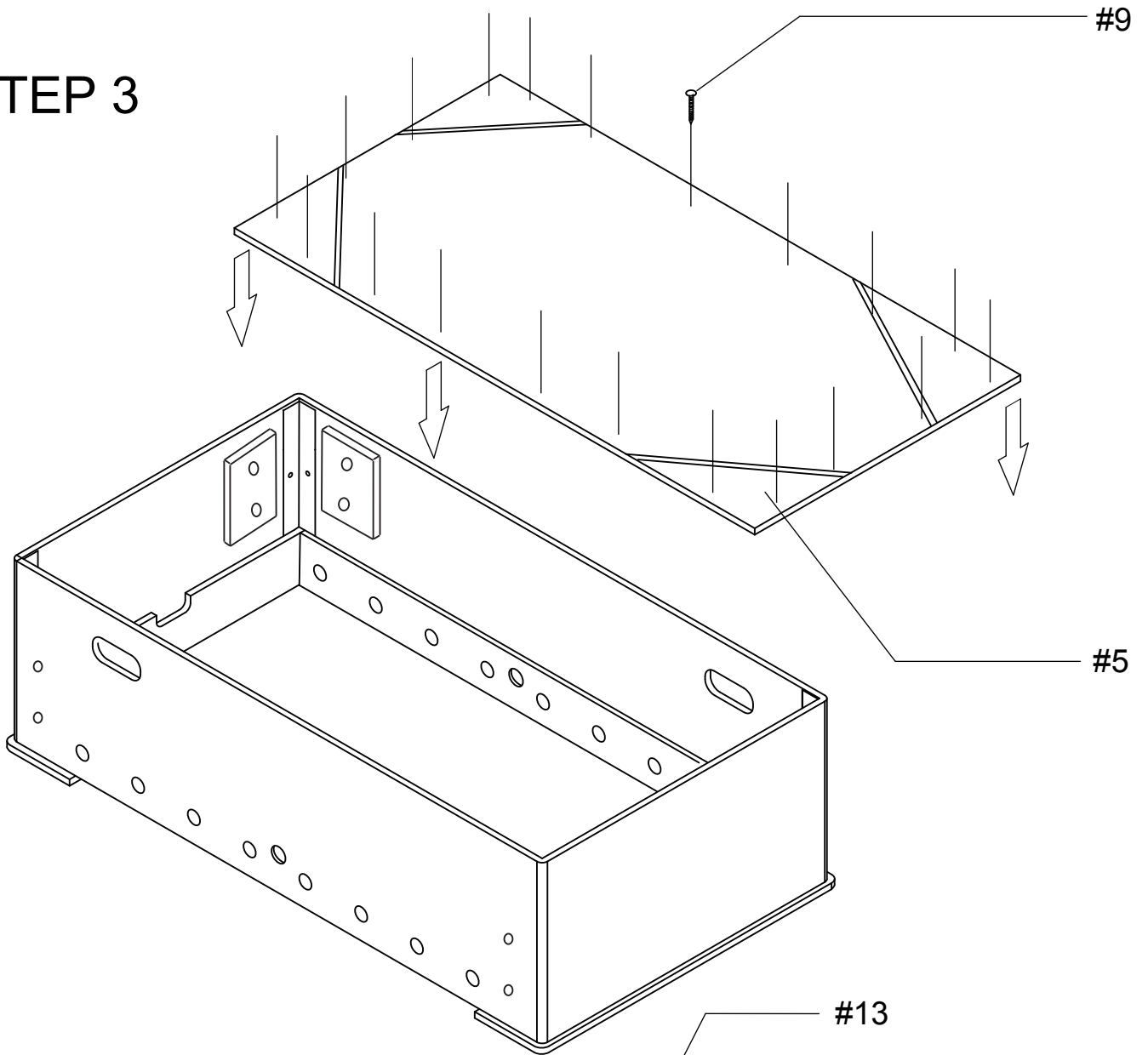

STEP 4

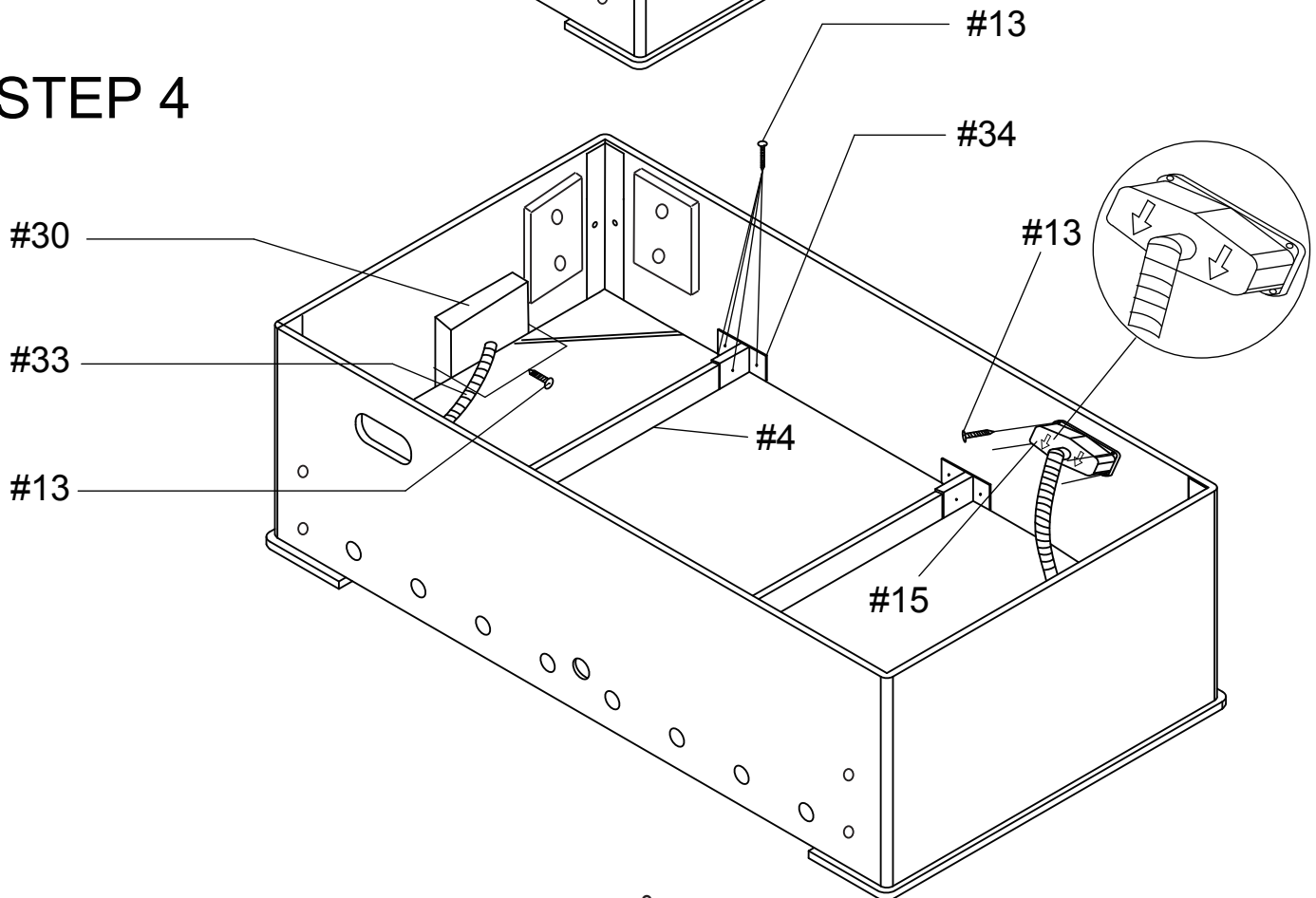

STEP 5

